

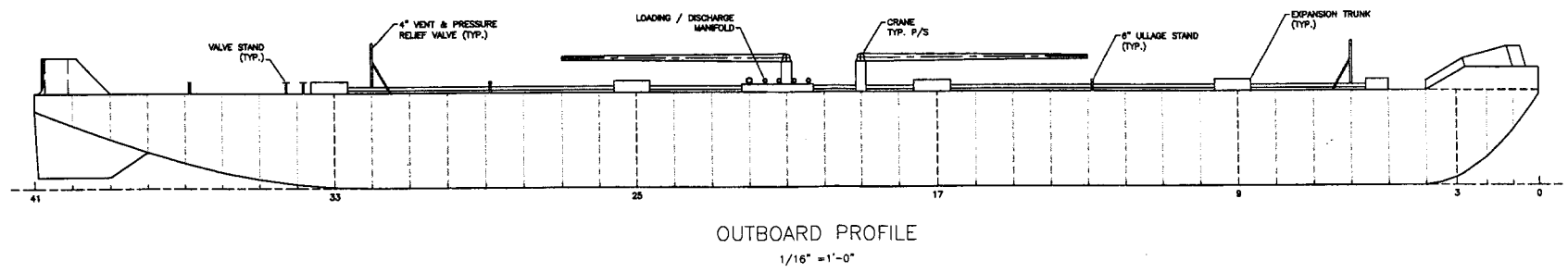

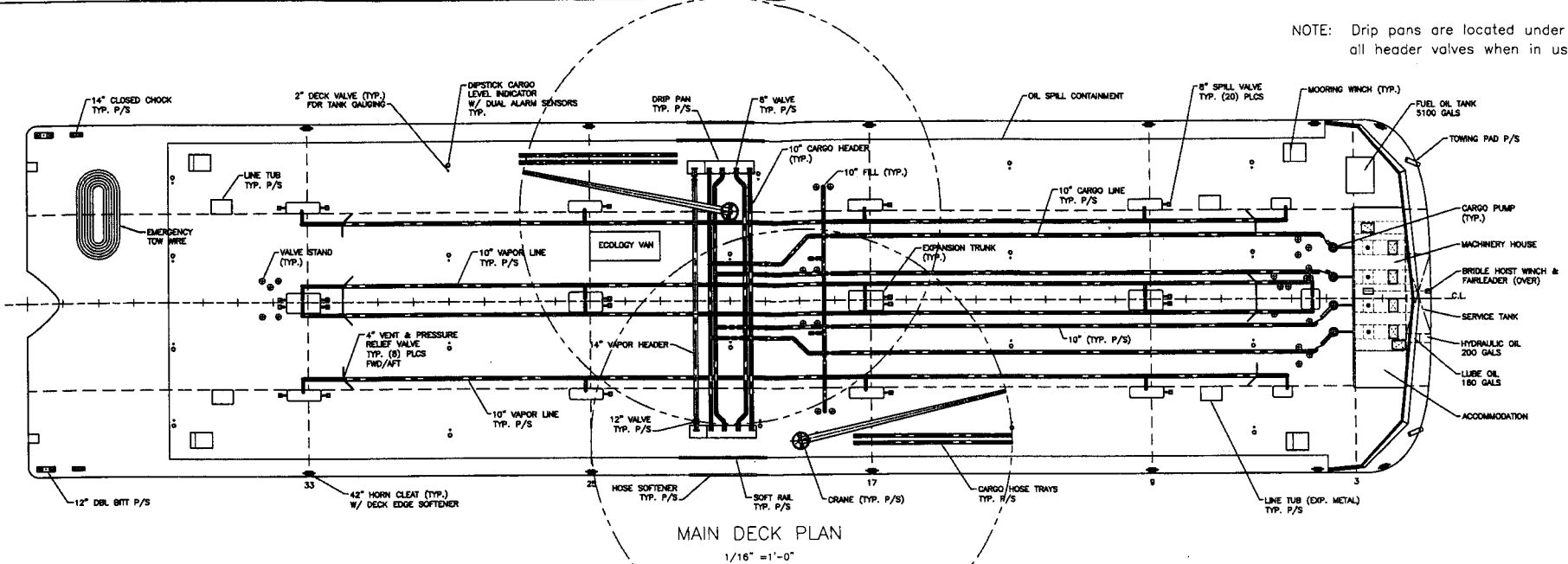

NOTE: Drip pans are located under all header valves when in use.

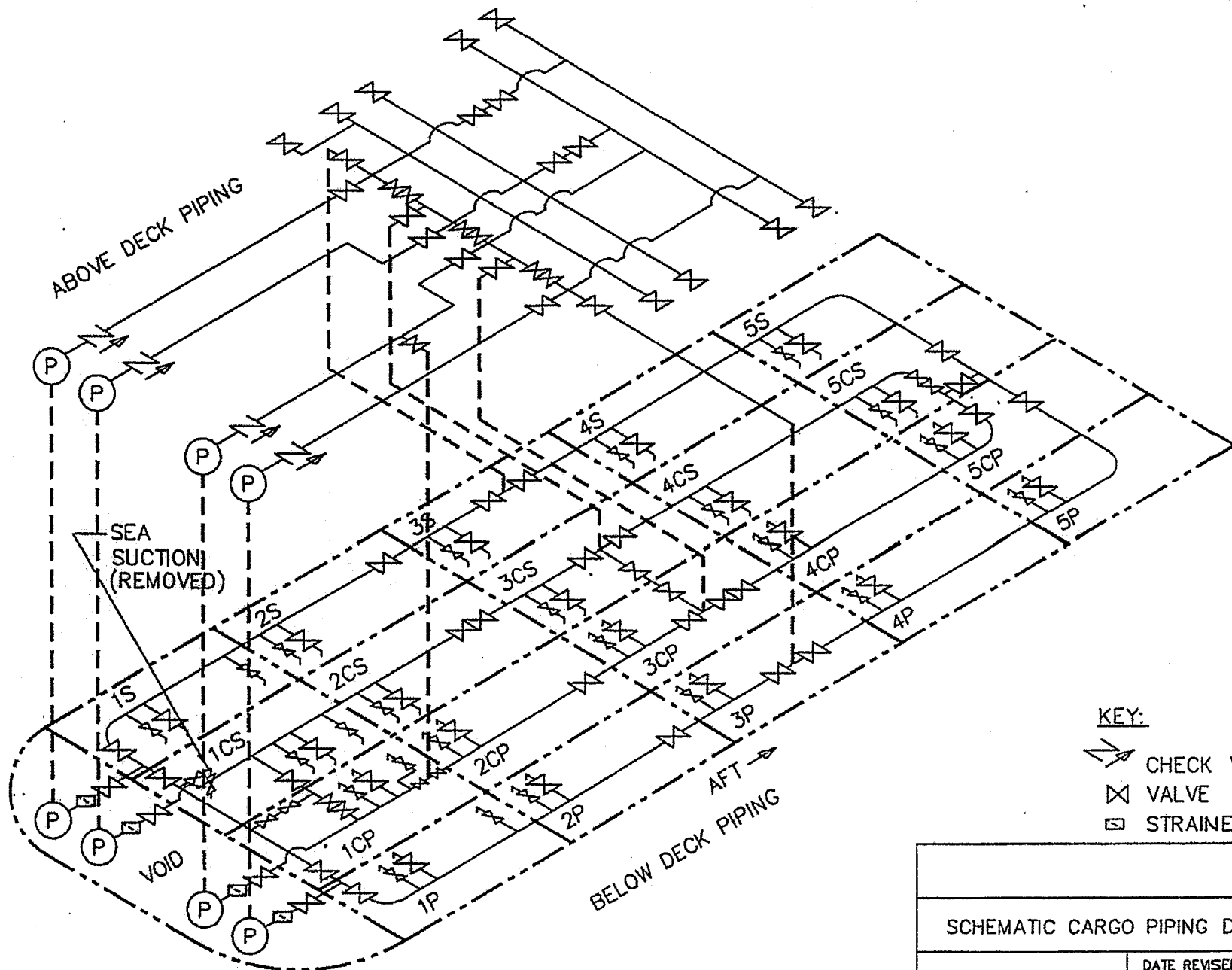



**KEY:**

-  CHECK VALVE
-  VALVE
-  STRAINER

**SCHEMATIC CARGO PIPING DIAGRAM**

DATE REVISED  
MAY., 2005





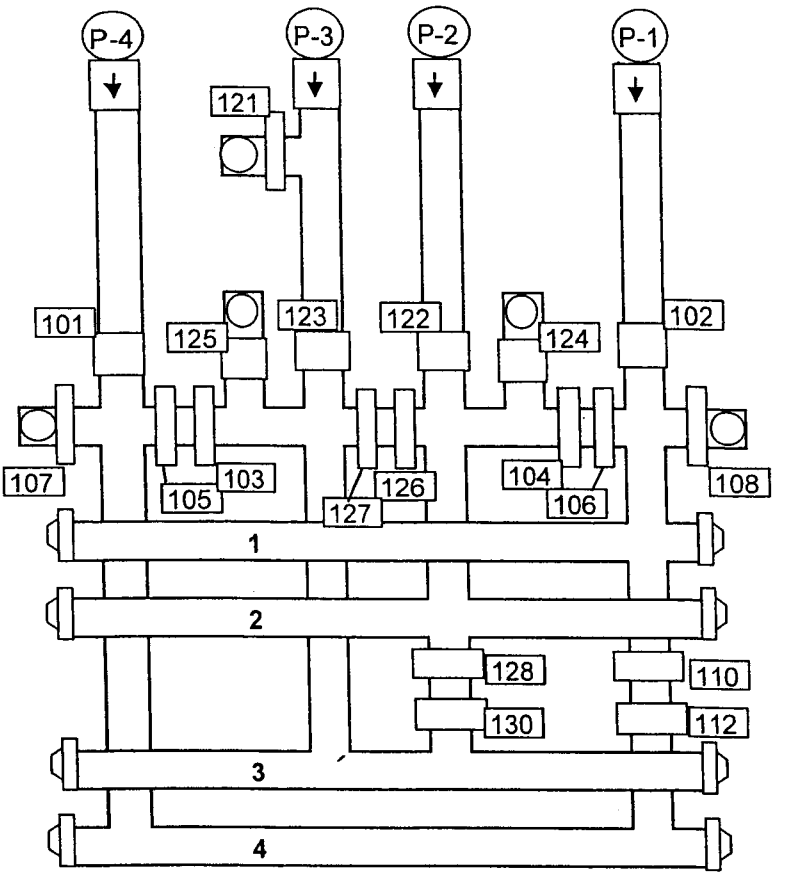
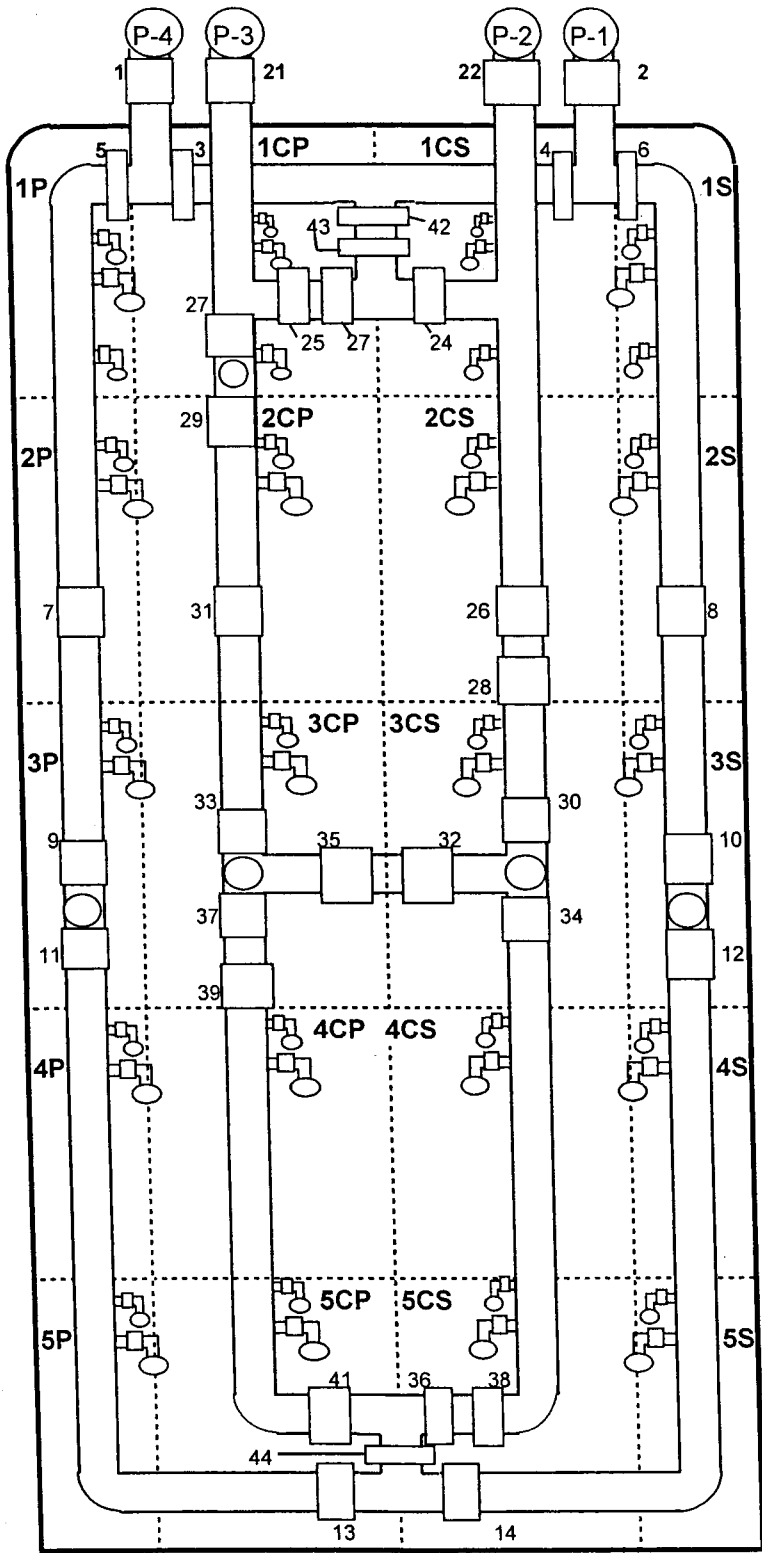

NOTE: ALL PUMPS AND RELATED VALVES ARE LOCATED IN TANKS #1CP AND #1CS.

Valve Line-up Plan for Voyage # \_\_\_\_\_



**Header Line Up**

Header 1	
Header 2	
Header 3	
Header 4	
Comments	

- KEY**
-  Check Valve
  -  Manifold Valve
  -  Deep-Well Pump
  -  Block Valves
  -  Tank Valves and Stripper
  -  Drops